

Basics

Duo deckchair

by Kettal Studio

kettal

Duo deckchair

Designer
Kettal Studio

Collection
Triconfort Basics

Reference
KS8100100

1/3

This design comes from the traditional chairs made of bulrush (Enea) this universal design is very common in different parts of the world: from Mediterranean areas until places in north of Europe.

Throughout the years many updates designs have been made: wood, plastic. Triconfort enea it's an outdoor version made in aluminium with synthetic fibers.

cm/inch

84/33

34/13,3

cm/inch

198 / 77,9

68,5 / 26,9

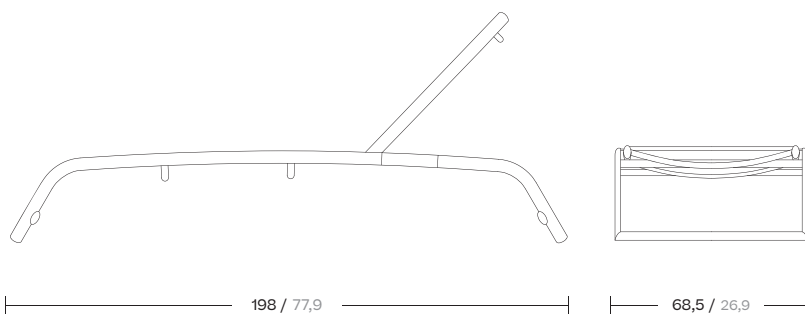

kettal

Duo deckchair

Designer
Kettal Studio

Collection
Triconfort Basics

Reference
KS8100100

2/3

Materials

Parallel Fabric
Heavy Load 100.000 Cycles,
Heavy Load Resistant 1000
Decitex, Kettalize-It, Resist U.v.
En-581-4, Easy Clean, Abrasion,
Resistance 30.000 Cycles,
Quikdry

Aluminium
Antioxy, Heavy Load, Resistant
En-1421, Kettalize-It, Anti-
Scratch, Easy Clean, Flame
Retardant M1, Eco Friendly
Ecoembes Recycling Process

Maintenance

Clean with mild soap using
sponge or cloth. Be gentle
while cleaning, do not scrub
aggressively the fabric. Once
cleaned please make sure you
remove soap excess.
In case of aggressive stains
clean with diluted household
bleach.
Clean stains promptly. The
longer it remains, more difficult
will be to remove.

Once cleaned the fabric steam
iron the fabric. Just use steam,
be carefull NOT placing the
iron directly in the fabric it will
get damage.

Frame Colour Options

Terrain Coatings



Slate Stone
01C



Mysty Smoke
02C



Ash
03C



Bone
04C



Tuff
05C



Wet Stone
06C



Sand Dune
07C



Dry Clay
08C



Arabica
09C



Sepia
19C



Rose Canyon
16C



Blossom
20C



Ruby Dust
18C



Sunset Glow
17C



Terrarosa
15C



Terracota
14C



Amber
13C



Ginger Root
12C



Desert Storm
11C



African Savannah
10C



Spring Meadow
28C



Kombu
29C



Forest Stream
27C



Sea Moss
26C



Glacier Ice
25C



Polar Sky
24C



Nightfall
23C



Indigo
22C



Wild Lupin
21C



Galena
33C

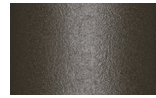

Bronze
30C



Corten
31C



Manganese
32C

Duo deckchair

Designer
Kettal Studio

Collection
Triconfort Basics

Reference
KS8100100

3/3

Other Characteristics



Stackable 4u.

Fabric Colour Options

Parallel Fabrics

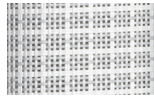

White Anemone
527

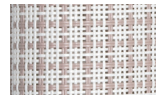

Lace Coral
528

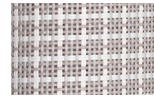

Padina
564

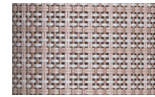

Saline
571

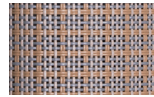

Alaria
572

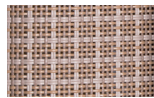

Sponge
536



Fucus
537

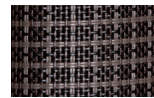

Urchin
547



Kelp
556

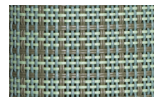

Turtle Grass
553

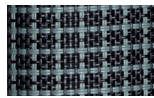

Deep Ocean
570



Winter Sea
569



Xenia
568



Plumaria
567



Irish Moss
559



Coral
562

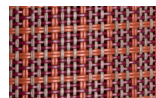

Dulse
565