

Mesh

Deckchair

by Patricia Urquiola

**kettal**

# Deckchair

Designer  
Patricia Urquiola

Collection  
Mesh

Reference  
KS1700800

1/3

Kettal Mesh collection recalls architectural facades, which filter the surrounding environment without stopping the light and air flow. Industrial and natural materials, hard and soft surfaces, transparent and solid volumes are putted face to face in order to create this family of outdoor furniture based in contrasts.

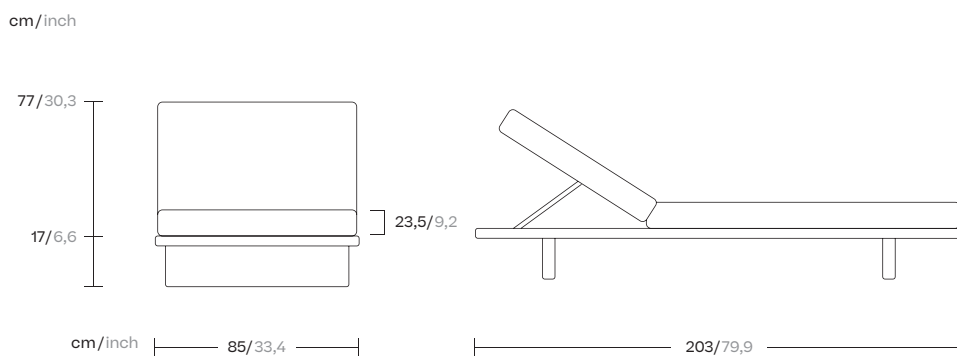

kettal

# Deckchair

Designer  
Patricia Urquiola

Collection  
Mesh

Reference  
KS1700800

2/3

## Materials

### Aluminium

Antioxy, Heavy Load, Resistant  
En-1421, Kettalize-It, Anti-  
Scratch, Easy Clean, Flame  
Retardant M1, Eco Friendly  
Ecoembes Recycling Process

### Teak

Eco-friendly, A-grade, Heavy  
Load

### Fabric

Heavy Load, 100.000 Cycles,  
Heavy Load Resistant 1000  
Decitex, Kettalize-It, Resist  
U.V. En-581-4, Easy Clean,  
Abrasion, Resistance 30.000  
Cycles, Quickdry

## Maintenance

Clean with mild soap using  
sponge or cloth. Be gentle  
while cleaning, do not scrub  
aggressively the fabric. Once  
cleaned please make sure you  
remove soap excess.

In case of aggressive stains  
clean with diluted household  
bleach.

Clean stains promptly. The  
longer it remains, more difficult  
will be to remove.

Once cleaned the fabric steam  
iron the fabric. Just use steam,  
be carefull NOT placing the  
iron directly in the fabric it will  
get damage.

## Frame Colour Options

## Terrain Paints



Chalk  
721



Bone  
678



Tuff  
103



Mist  
773



Flint  
734



London Clay  
729



Mahogany  
100



Carbon  
737



Lilac  
104



Feldspar  
082



Sepia  
088

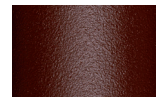

Terra Rossa  
087



Magma  
086



Terracota  
085



Sahara  
139

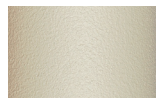

Camomile  
106



Aquamarine  
107



Cobalt  
089

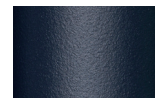

Indigo  
094



Jade  
091

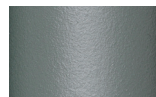

Onyx  
101



Juniper  
092



Amazon  
102



Bronze  
093



Corten  
727



Claystone  
741

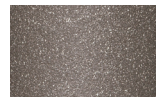

Sand Storm  
132



Pumice  
131

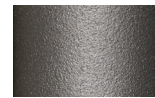

Galena  
105



Manganese  
726

## Frame Colour Options

## Other



Teak  
904

# Deckchair

Designer  
Patricia Urquiola

Collection  
Mesh

Reference  
KS1700800

3/3

## Seat/Back Cushion

## Terrain Laminate Fabrics

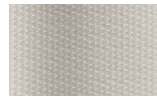

White Cliffs  
290



Dry Sand  
285

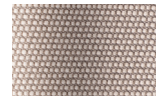

Porous Grey  
291

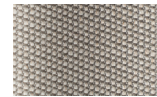

Limestone  
292

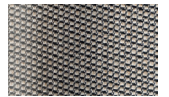

Fog  
289



Deer  
286



Wet Sand  
287



Cobblestone  
302



Cyprus Umber  
301



Loam  
297



Charcoal  
293



Arctic  
295

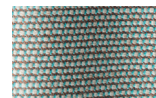

Fjord  
248



Cerulean  
314



Caribbean  
298



Atlantic  
311



Rainforest  
312



Lagoon  
249



Cedar  
288

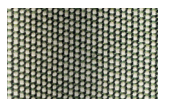

Moss  
296



Olive  
313



Autumn  
315

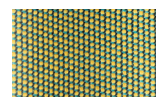

Summer Sky  
317

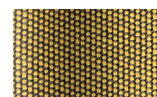

Golden Sand  
303



Flamma  
304

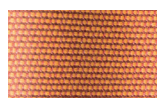

Sunrise  
299



Saffron  
305



Burnt Sienna  
306

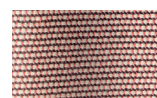

Ash Rose  
294



Cooper  
316

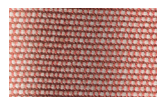

Dusk Pink  
307

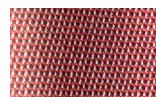

Flamingo  
310



Coral  
309



Sandstone  
308

Mesh

Double deckchair

by Patricia Urquiola

**kettal**

# Double deckchair

Designer  
Patricia Urquiola

Collection  
Mesh

Reference  
KS1700900

1/3

Kettal Mesh collection recalls architectural facades, which filter the surrounding environment without stopping the light and air flow. Industrial and natural materials, hard and soft surfaces, transparent and solid volumes are putted face to face in order to create this family of outdoor furniture based in contrasts.

cm/inch

72/28,3

31/12

cm/inch

158/62,2

201/79,1

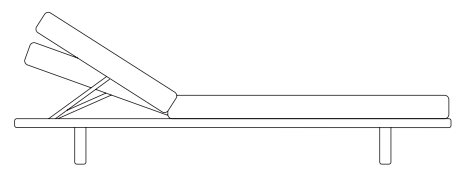
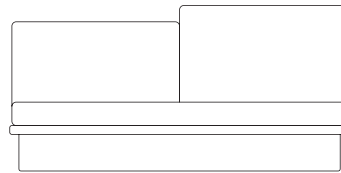

kettal

# Double deckchair

Designer  
Patricia Urquiola

Collection  
Mesh

Reference  
KS1700900

2/3

## Materials

**Aluminium**  
Antioxy, Heavy Load, Resistant  
En-1421, Kettalize-It, Anti-  
Scratch, Easy Clean, Flame  
Retardant M1, Eco Friendly  
Ecoembes Recycling Process

**Teak**  
Eco-friendly, A-grade, Heavy  
Load

**Fabric**  
Heavy Load, 100.000 Cycles,  
Heavy Load Resistant 1000  
Decitex, Kettalize-It, Resist  
U.V. En-581-4, Easy Clean,  
Abrasion, Resistance 30.000  
Cycles, Quickdry

## Maintenance

Clean with mild soap using  
sponge or cloth. Be gentle  
while cleaning, do not scrub  
aggressively the fabric. Once  
cleaned please make sure you  
remove soap excess.

In case of aggressive stains  
clean with diluted household  
bleach.

Clean stains promptly. The  
longer it remains, more difficult  
will be to remove.

Once cleaned the fabric steam  
iron the fabric. Just use steam,  
be carefull NOT placing the  
iron directly in the fabric it will  
get damage.

## Frame Colour Options



Chalk  
721



Bone  
678



Tuff  
103



Mist  
773



Flint  
734



London Clay  
729



Mahogany  
100



Carbon  
737



Lilac  
104



Feldspar  
082



Sepia  
088

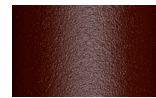

Terra Rossa  
087

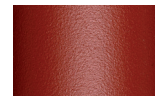

Magma  
086



Terracota  
085



Sahara  
139

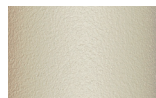

Camomile  
106



Aquamarine  
107



Cobalt  
089

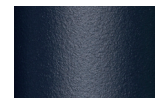

Indigo  
094



Jade  
091

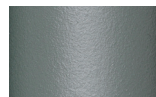

Onyx  
101



Juniper  
092



Amazon  
102

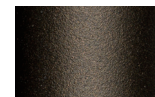

Bronze  
093



Corten  
727

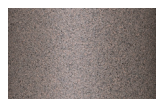

Claystone  
741



Sand Storm  
132



Pumice  
131



Galena  
105



Manganese  
726

## Frame Colour Options



Teak  
904

## Other

# Double deckchair

Designer  
Patricia Urquiola

Collection  
Mesh

Reference  
KS1700900

3/3

## Seat/Back Cushion

## Terrain Laminate Fabrics

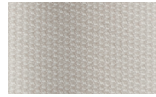

White Cliffs  
290



Dry Sand  
285

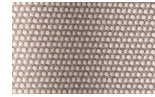

Porous Grey  
291

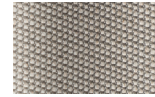

Limestone  
292

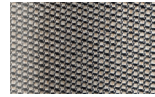

Fog  
289

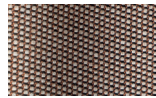

Deer  
286



Wet Sand  
287



Cobblestone  
302



Cyprus Umber  
301

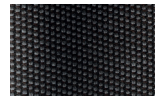

Loam  
297



Charcoal  
293



Arctic  
295

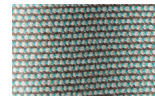

Fjord  
248



Cerulean  
314



Caribbean  
298



Atlantic  
311



Rainforest  
312

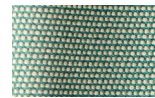

Lagoon  
249



Cedar  
288

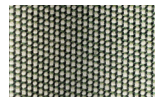

Moss  
296

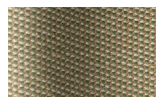

Olive  
313



Autumn  
315

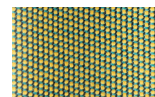

Summer Sky  
317

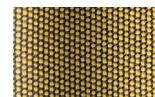

Golden Sand  
303



Flamma  
304

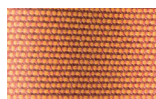

Sunrise  
299



Saffron  
305



Burnt Sienna  
306

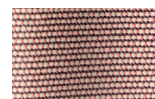

Ash Rose  
294

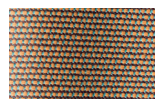

Cooper  
316

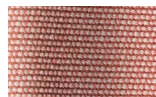

Dusk Pink  
307

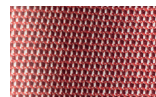

Flamingo  
310



Coral  
309

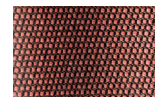

Sandstone  
308



Mesh

Left chaise longue

(1 Side connection)

by Patricia Urquiola

**kettal**

# Left chaise longue

Designer  
Patricia Urquiola

Collection  
Mesh

Reference  
KS1701100

1/3

Kettal Mesh collection recalls architectural facades, which filter the surrounding environment without stopping the light and air flow. Industrial and natural materials, hard and soft surfaces, transparent and solid volumes are putted face to face in order to create this family of outdoor furniture based in contrasts.

cm/inch

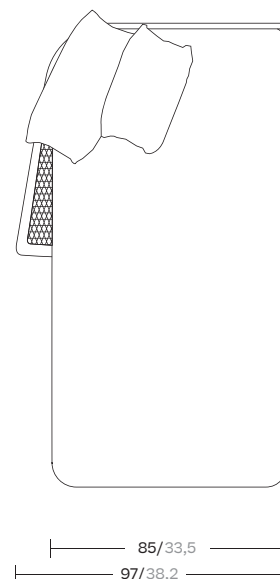
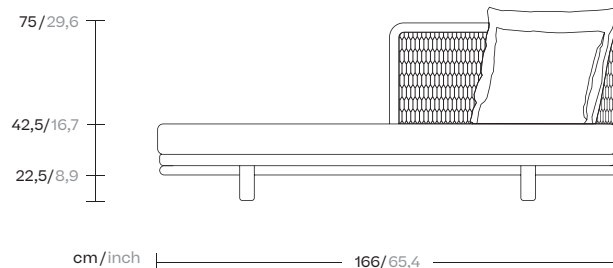

kettal

# Left chaise longue

Designer  
Patricia Urquiola

Collection  
Mesh

Reference  
KS1701100

2/3

## Materials

**Aluminium**  
Antioxy, Heavy Load, Resistant En-1421, Kettalize-It, Anti-Scratch, Easy Clean, Flame Retardant M1, Eco Friendly Ecoembes Recycling Process

**Teak**  
Eco-friendly, A-grade, Heavy Load

**Fabric**  
Heavy Load, 100.000 Cycles, Heavy Load Resistant 1000 Decitex, Kettalize-It, Resist U.V. En-581-4, Easy Clean, Abrasion, Resistance 30.000 Cycles, Quickdry

## Maintenance

Clean with mild soap using sponge or cloth. Be gentle while cleaning, do not scrub aggressively the fabric. Once cleaned please make sure you remove soap excess.

In case of aggressive stains clean with diluted household bleach.

Clean stains promptly. The longer it remains, more difficult will be to remove.

Once cleaned the fabric steam iron the fabric. Just use steam, be carefull NOT placing the iron directly in the fabric it will get damage.

## Frame Colour Options



Chalk  
721



Bone  
678



Tuff  
103



Mist  
773



Flint  
734



London Clay  
729



Mahogany  
100



Carbon  
737



Lilac  
104



Feldspar  
082



Sepia  
088



Terra Rossa  
087



Magma  
086



Terracota  
085



Sahara  
139

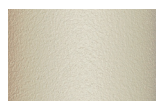

Camomile  
106



Aquamarine  
107



Cobalt  
089

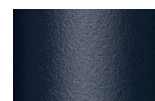

Indigo  
094



Jade  
091



Onyx  
101



Juniper  
092



Amazon  
102



Bronze  
093



Corten  
727



Claystone  
741

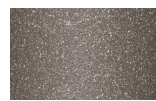

Sand Storm  
132



Pumice  
131



Galena  
105



Manganese  
726

## Frame Colour Options



Teak  
904

## Other

# Left chaise longue

Designer  
Patricia Urquiola

Collection  
Mesh

Reference  
KS1701100

3/3

## Seat/Back Cushion

## Terrain Laminate Fabrics

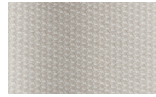

White Cliffs  
290



Dry Sand  
285

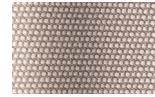

Porous Grey  
291

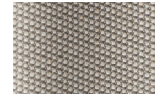

Limestone  
292

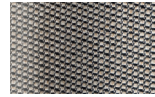

Fog  
289

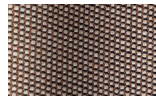

Deer  
286



Wet Sand  
287



Cobblestone  
302



Cyprus Umber  
301

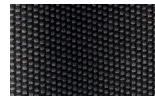

Loam  
297



Charcoal  
293



Arctic  
295

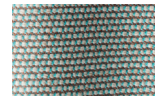

Fjord  
248



Cerulean  
314



Caribbean  
298



Atlantic  
311



Rainforest  
312

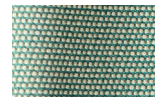

Lagoon  
249



Cedar  
288

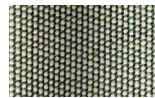

Moss  
296



Olive  
313



Autumn  
315

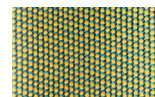

Summer Sky  
317

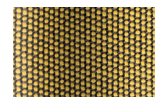

Golden Sand  
303



Flamma  
304

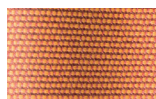

Sunrise  
299



Saffron  
305



Burnt Sienna  
306

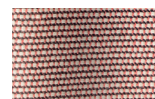

Ash Rose  
294

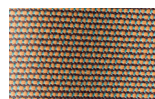

Cooper  
316

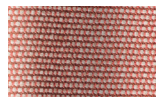

Dusk Pink  
307

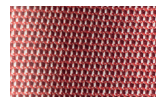

Flamingo  
310



Coral  
309

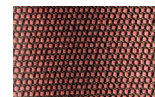

Sandstone  
308

Mesh

Left chaise longue

(1 Side connection)

by Patricia Urquiola

**kettal**

# Right chaise longue

Designer  
Patricia Urquiola

Collection  
Mesh

Reference  
KS1701200

1/3

Kettal Mesh collection recalls architectural facades, which filter the surrounding environment without stopping the light and air flow. Industrial and natural materials, hard and soft surfaces, transparent and solid volumes are putted face to face in order to create this family of outdoor furniture based in contrasts.

cm/inch

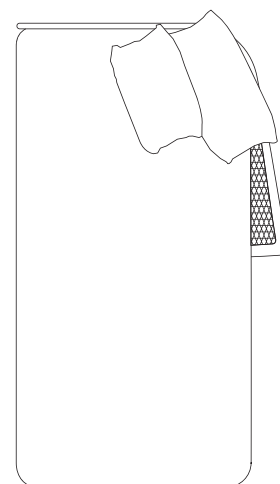
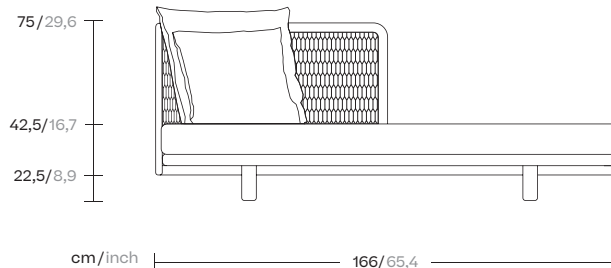

kettal

# Right chaise longue

Designer  
Patricia Urquiola

Collection  
Mesh

Reference  
KS1701200

2/3

## Materials

**Aluminium**  
Antioxy, Heavy Load, Resistant En-1421, Kettalize-It, Anti-Scratch, Easy Clean, Flame Retardant M1, Eco Friendly Ecoembes Recycling Process

**Teak**  
Eco-friendly, A-grade, Heavy Load

**Fabric**  
Heavy Load, 100.000 Cycles, Heavy Load Resistant 1000 Decitex, Kettalize-It, Resist U.V. En-581-4, Easy Clean, Abrasion, Resistance 30.000 Cycles, Quickdry

## Maintenance

Clean with mild soap using sponge or cloth. Be gentle while cleaning, do not scrub aggressively the fabric. Once cleaned please make sure you remove soap excess.

In case of aggressive stains clean with diluted household bleach.

Clean stains promptly. The longer it remains, more difficult will be to remove.

Once cleaned the fabric steam iron the fabric. Just use steam, be carefull NOT placing the iron directly in the fabric it will get damage.

## Frame Colour Options



Chalk  
721



Bone  
678



Tuff  
103



Mist  
773



Flint  
734



London Clay  
729



Mahogany  
100



Carbon  
737



Lilac  
104



Feldspar  
082



Sepia  
088

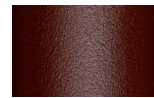

Terra Rossa  
087

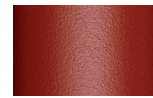

Magma  
086



Terracota  
085



Sahara  
139

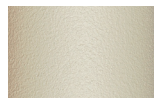

Camomile  
106



Aquamarine  
107



Cobalt  
089

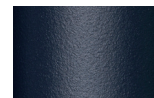

Indigo  
094



Jade  
091



Onyx  
101



Juniper  
092

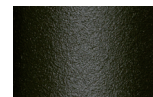

Amazon  
102

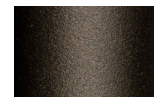

Bronze  
093



Corten  
727

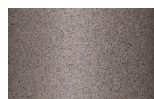

Claystone  
741



Sand Storm  
132



Pumice  
131



Galena  
105



Manganese  
726

## Frame Colour Options



Teak  
904

## Other

# Right chaise longue

Designer  
Patricia Urquiola

Collection  
Mesh

Reference  
KS1701200

3/3

## Seat/Back Cushion

## Terrain Laminate Fabrics

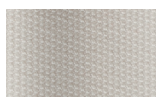

White Cliffs  
290



Dry Sand  
285



Porous Grey  
291

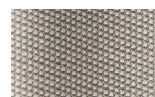

Limestone  
292



Fog  
289



Deer  
286



Wet Sand  
287



Cobblestone  
302



Cyprus Umber  
301



Loam  
297



Charcoal  
293



Arctic  
295

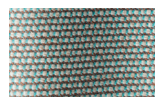

Fjord  
248



Cerulean  
314



Caribbean  
298



Atlantic  
311



Rainforest  
312



Lagoon  
249



Cedar  
288



Moss  
296



Olive  
313

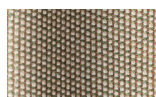

Autumn  
315

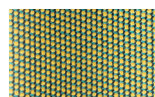

Summer Sky  
317

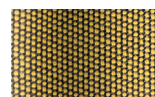

Golden Sand  
303



Flamma  
304

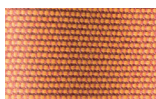

Sunrise  
299



Saffron  
305



Burnt Sienna  
306

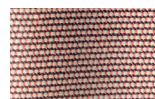

Ash Rose  
294

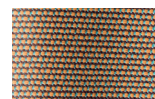

Cooper  
316

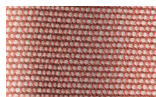

Dusk Pink  
307



Flamingo  
310

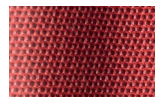

Coral  
309



Sandstone  
308