

---

# Dock versione bassa

DIVANI

2019

Piero Lissoni



## Descrizione

---

Rasoterra per accomodarsi all'orientale, Dock nella versione con altezza di seduta bassa è un sistema di imbottiti dall'anima molteplice, altamente flessibile grazie alle innumerevoli configurazioni che i numerosi elementi della collezione sono in grado di generare. La vocazione orizzontale del progetto è sottolineata dal pianale, piattaforma dalla forte presenza materica attorno alla quale si sviluppa tutto il sistema, oltre che elemento dinamico che si allunga ai lati per formare un piano d'appoggio. Il bracciolo è sottile, in due profondità, generosamente imbottito come lo schienale. Anche i cuscini giocano con dimensioni e proporzioni, rendendo possibile la creazione di composizioni bifacciali, angolari, chaise longue, con o senza schienale, soluzioni a centro stanza ma anche più tradizionali. Completano il sistema una serie di accessori dedicati che offrono un panorama variegato di possibilità: tra i cuscini della seduta si possono infatti inserire elementi extra quali confortevoli braccioli imbottiti, mentre sul pianale si possono posizionare elementi di servizio, di appoggio per il corpo e gli oggetti in grado di garantire una maggiore personalizzazione per vivere e concepire il sistema a propria misura. I rivestimenti sono previsti in tessuto e pelle. Dock è proposto anche nella versione con seduta sollevata da terra.

# Informazioni tecniche

---

**Telaio interno sedile (base rivestita)**

tubolari e profilati d'acciaio, pannello in multistrato di legno, fodera in fibra di poliestere

**Telaio interno sedile (base legno)**

tubolari e profilati d'acciaio, pannello in multistrato di legno impiallacciato, legno massello

**Telaio interno schienale e bracciolo**

tubolari e profilati d'acciaio

**Imbottitura cuscino sedile**

poliuretano sagomato a densità differenziata, piuma sterilizzata, fodera in fibra di poliestere

**Imbottitura cuscino schienale**

piuma sterilizzata, fodera in fibra di poliestere

**Piano**

pannello in fibra di legno MDF impiallacciato

**Capsula**

acciaio

**Piedini**

materiale termoplastico

**Supporto bracciolo (DA31B)**

alluminio e acciaio

**Piano bracciolo (DA31B)**

legno massello, poliuretano sagomato a densità differenziata, fodera in fibra di poliestere

**Supporto elemento di servizio**

acciaio

**Piano elemento di servizio**

legno massello o vetro

**Puntali**

materiale plastico

**Rivestimento**

tessuto (profilo cannetè) o pelle

# Disegni tecnici

**DB198**

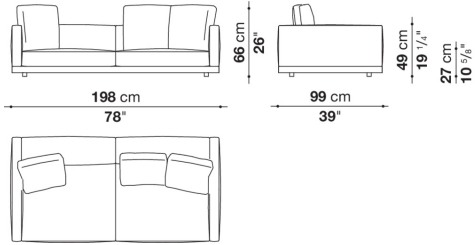

**DB239S\_1**

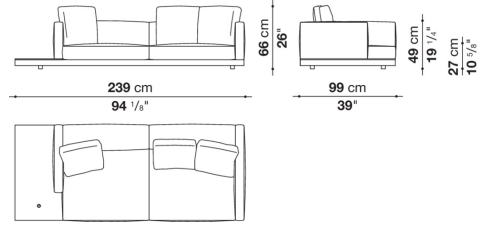

**DB239D\_1**

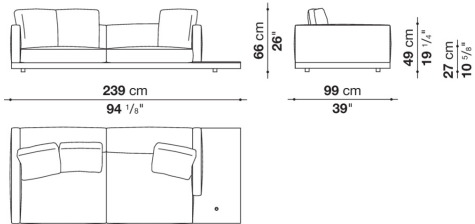

**DB239S\_2**

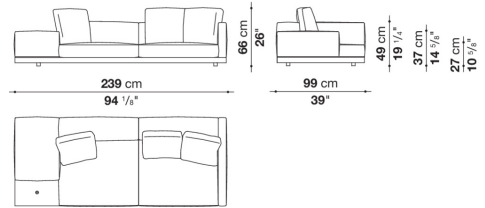

**DB239D\_2**

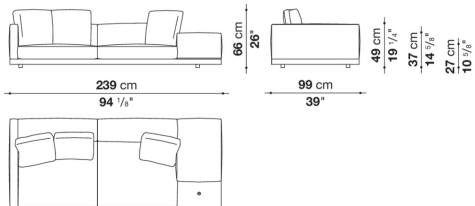

**DB280\_1**

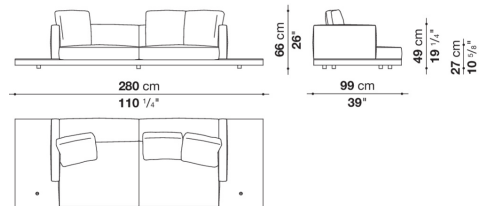

**DB280\_2**

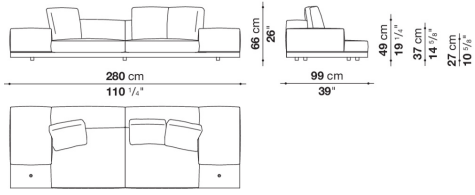

**DB280S\_3**

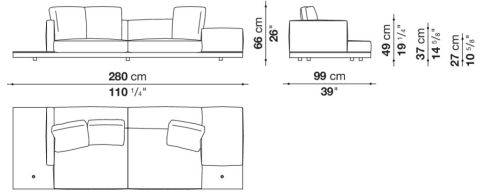

**DB280D\_3**

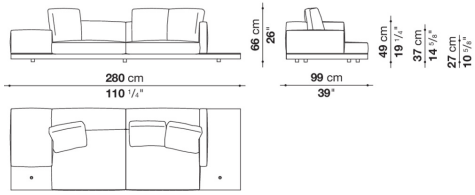

**DB288**

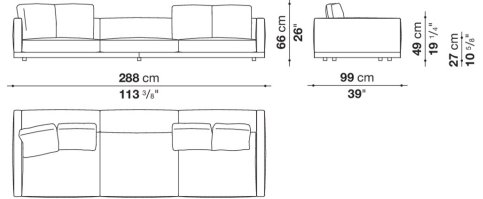

**DB329S\_1**

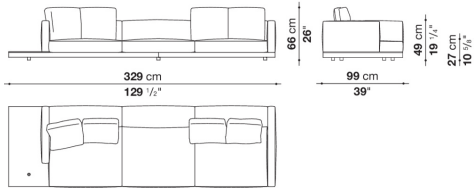

**DB329D\_1**

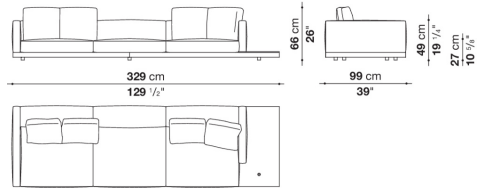

DB329S\_2

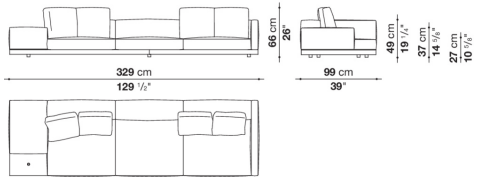

DB329D\_2

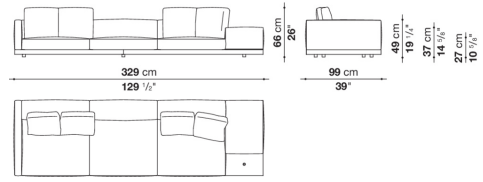

DB370\_1

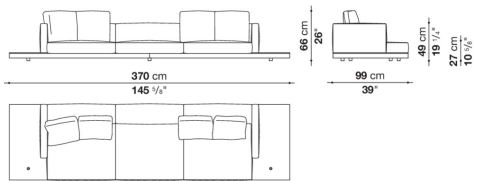

DB370\_2

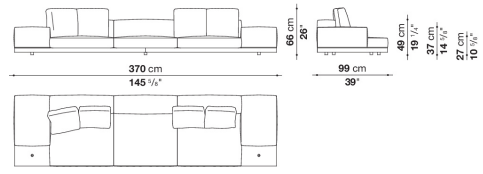

DB370S\_3

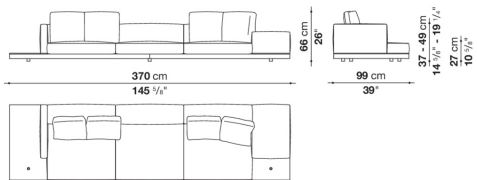

DB370D\_3

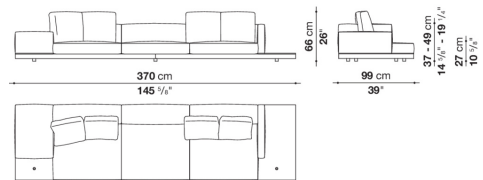

**DB189TS**

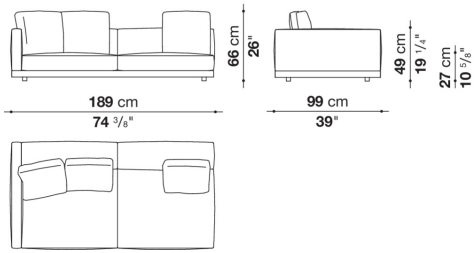

**DB189TD**

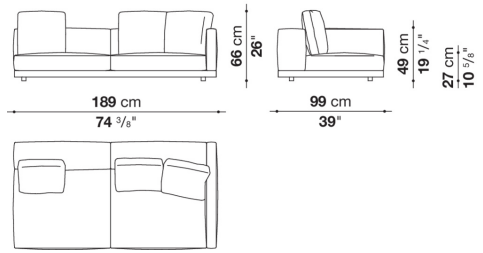

**DB230TS\_1**

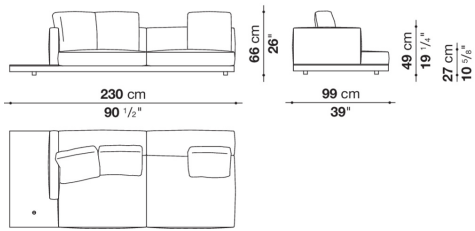

**DB230TD\_1**

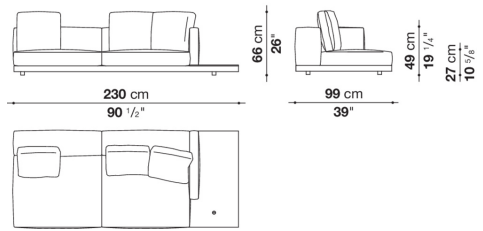

**DB230TS\_3**

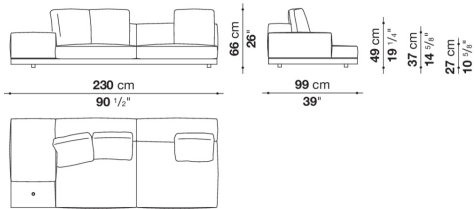

**DB230TD\_3**

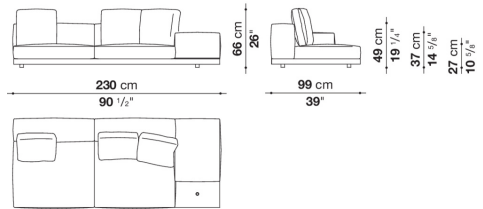

**DB320TS\_1**

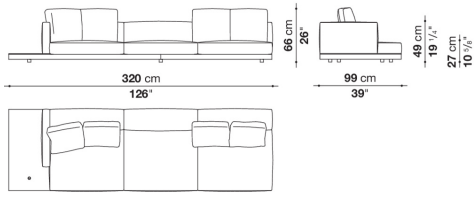

**DB320TD\_1**

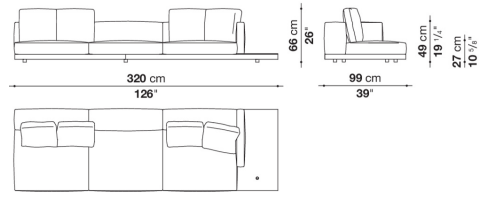

**DB320TS\_3**

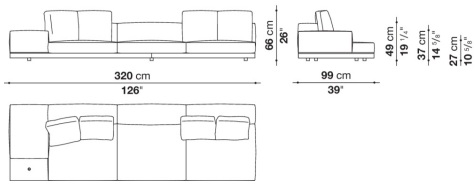

**DB320TD\_3**

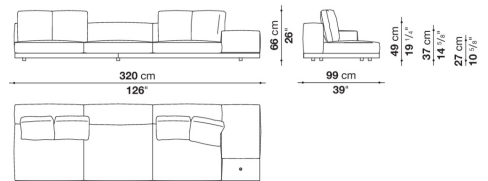

**DB279AS\_1**

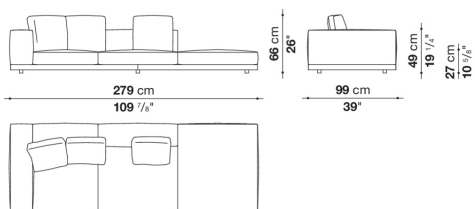

**DB279AD\_1**

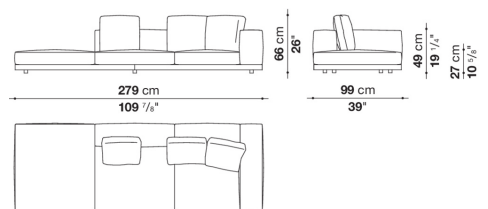

**DB288AS**

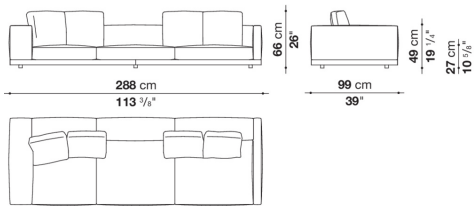

**DB288AD**

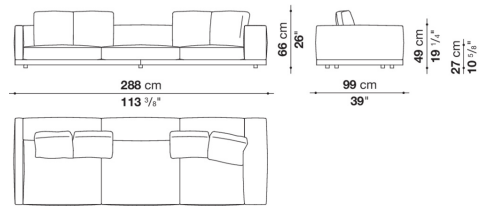

**DB288AS\_2**

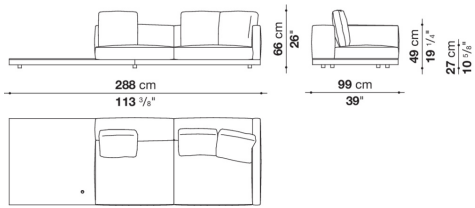

**DB288AD\_2**

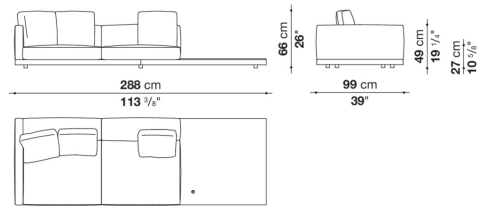

**DB329AS\_2**

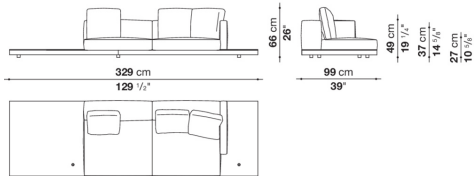

**DB329AD\_2**

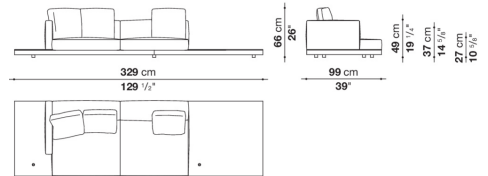



DB329AS\_4

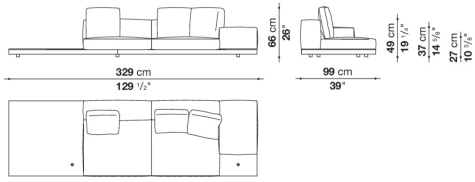

DB329AD\_4

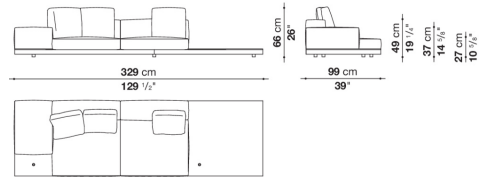

DB150LS\_1

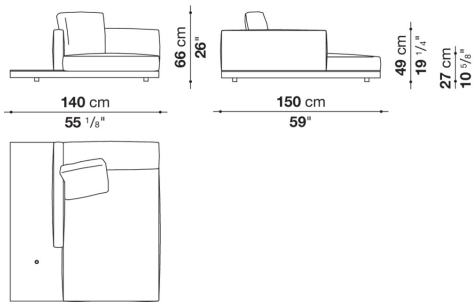

DB150LD\_1

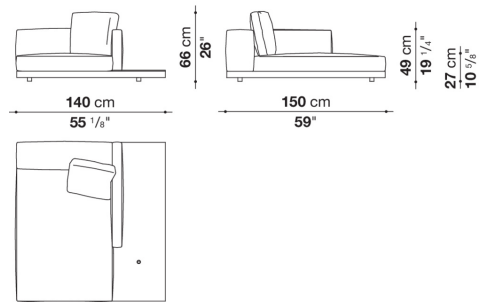

DB150LS\_2

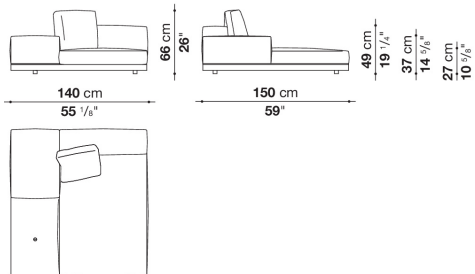

DB150LD\_2

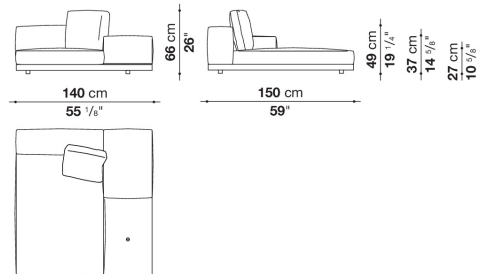

**DB280P**

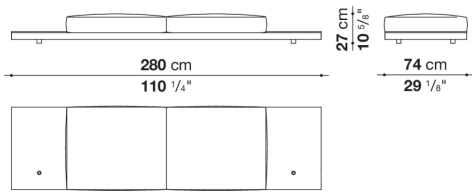

**DB320PS\_2**

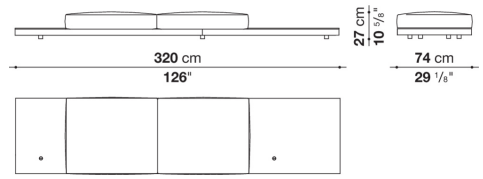

**DB320PD\_2**

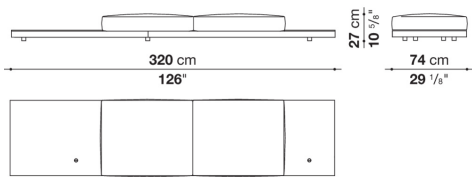

**DB370P**

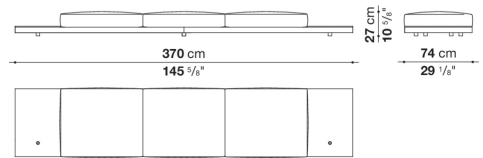

**DB370PS**

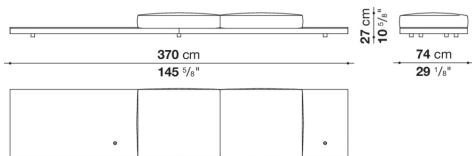

**DB370PD**

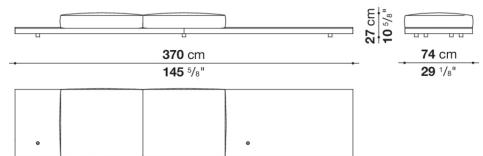

**DBL198**

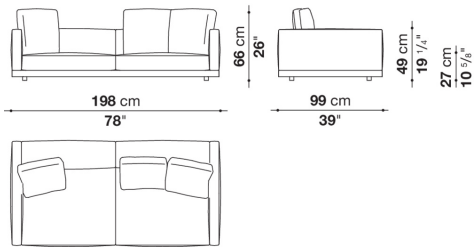

**DBL239S\_1**

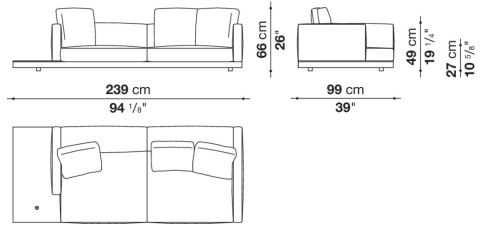

**DBL239D\_1**

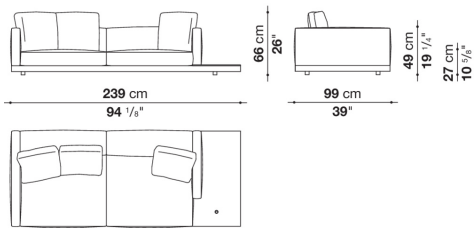

**DBL239S\_2**

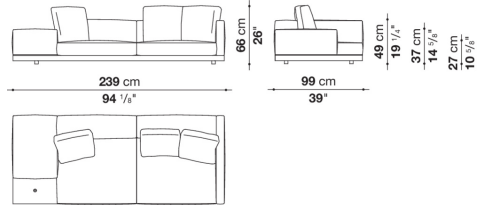

**DBL239D\_2**

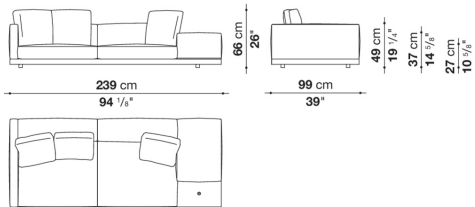

**DBL280\_1**

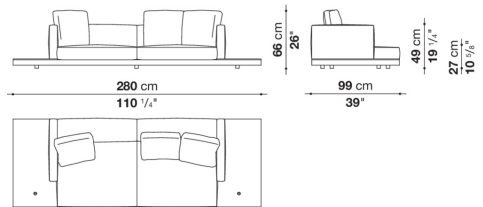

**DBL280\_2**

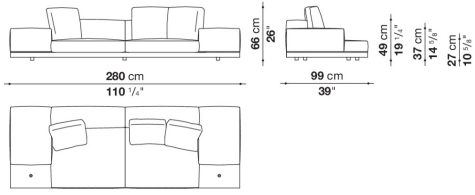

**DBL280S\_3**

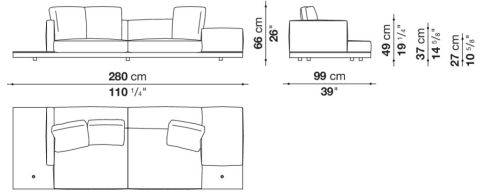

**DBL280D\_3**

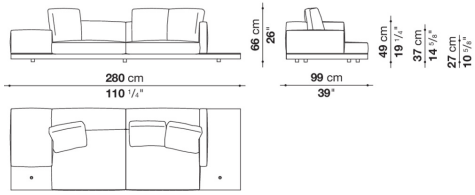

**DBL288**

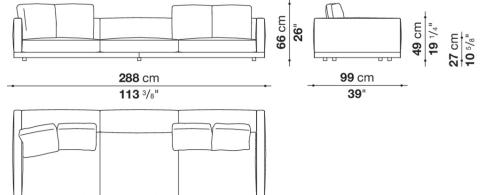

**DBL329S\_1**

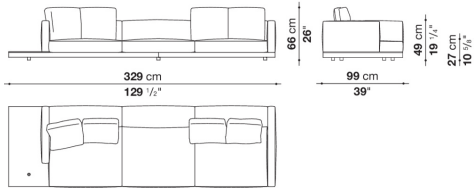

**DBL329D\_1**

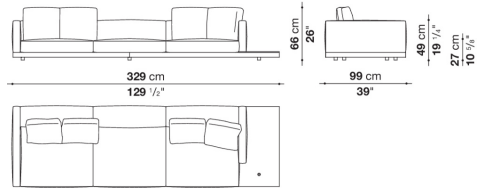

DBL329S\_2

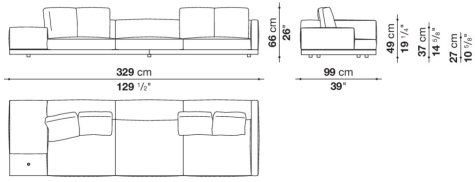

DBL329D\_2

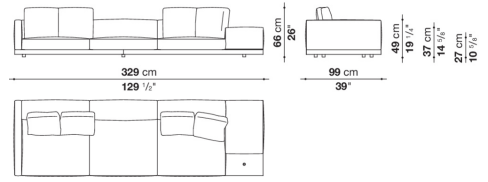

DBL370\_1

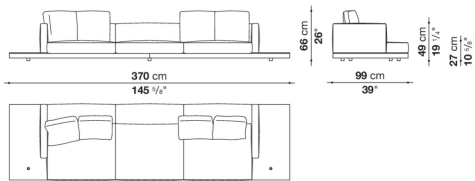

DBL370\_2

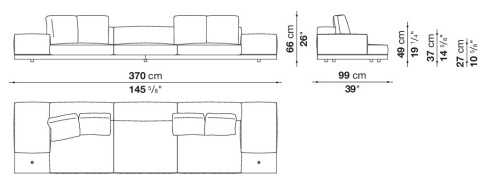

DBL370S\_3

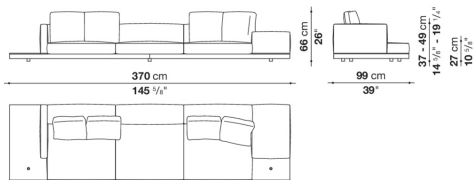

DBL370D\_3

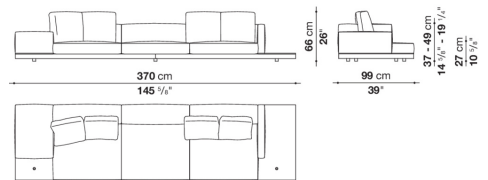

**DBL189TS**

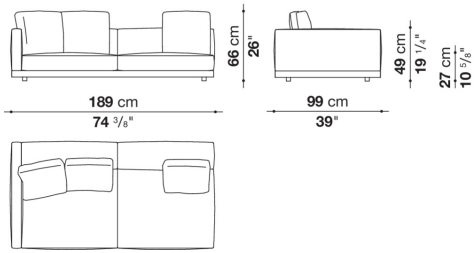

**DBL189TD**

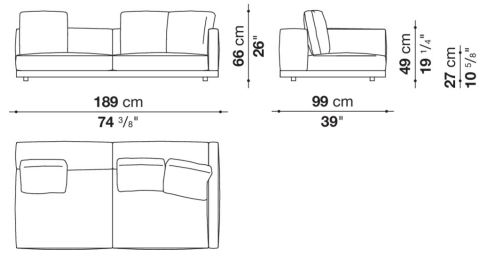

**DBL230TS\_1**

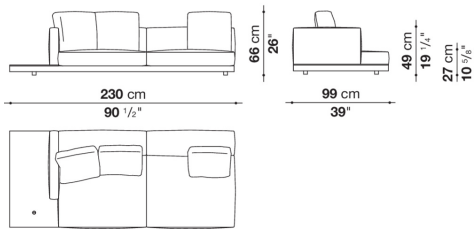

**DBL230TD\_1**

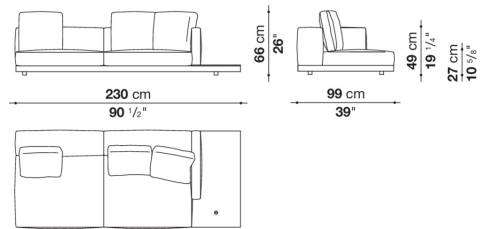

**DBL230TS\_3**

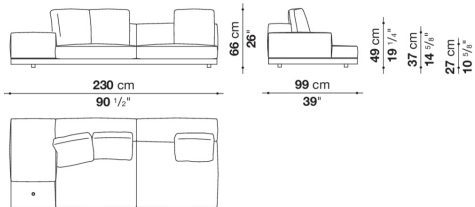

**DBL230TD\_3**

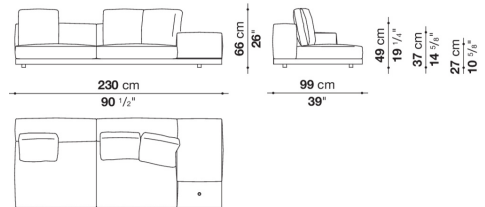

**DBL320TS\_1**

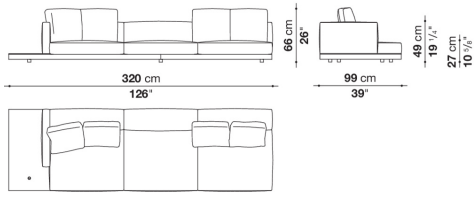

**DBL320TD\_1**

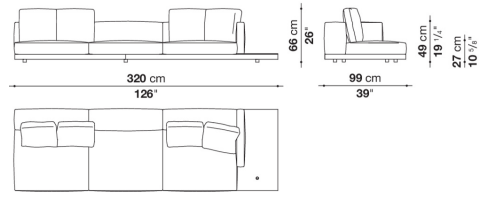

**DBL320TS\_3**

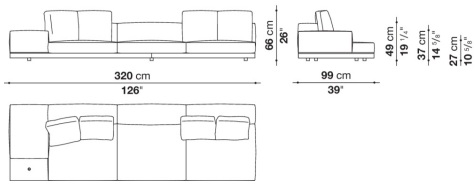

**DBL320TD\_3**

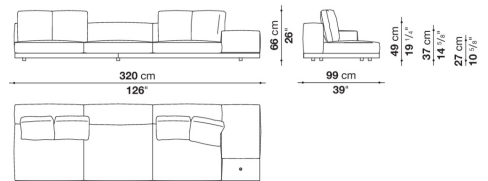

**DBL279AS\_1**

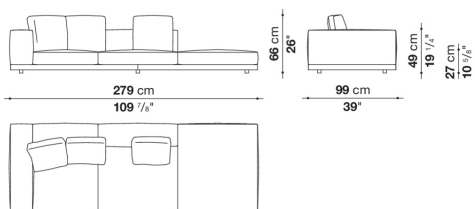

**DBL279AD\_1**

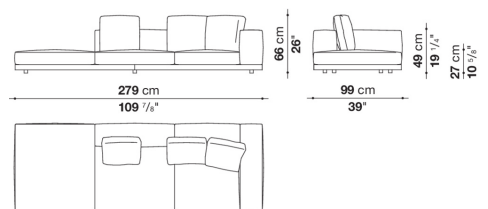

**DBL288AS**

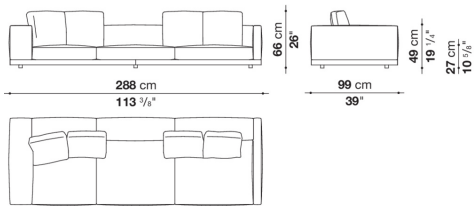

**DBL288AD**

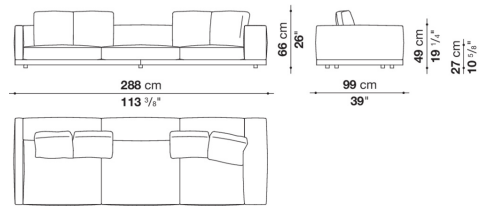

**DBL288AS\_2**

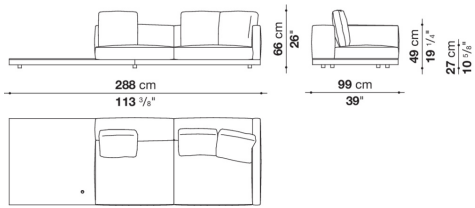

**DBL288AD\_2**

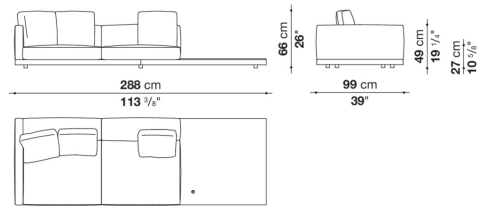

**DBL329AS\_2**

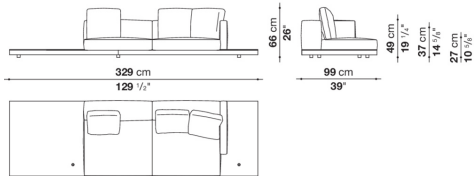

**DBL329AD\_2**

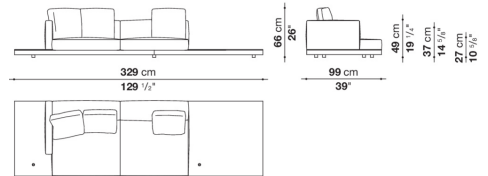



DBL329AS\_4

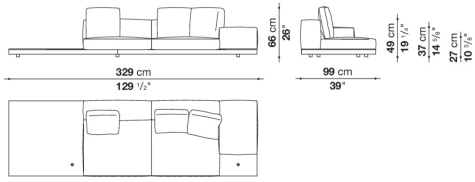

DBL329AD\_4

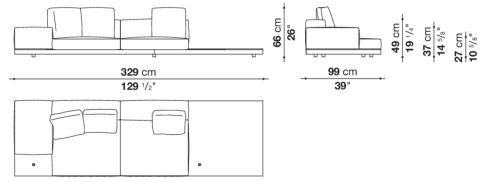

DBL150LS\_1

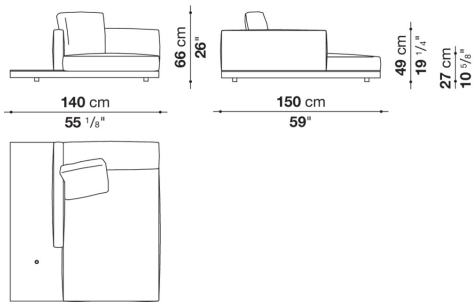

DBL150LD\_1

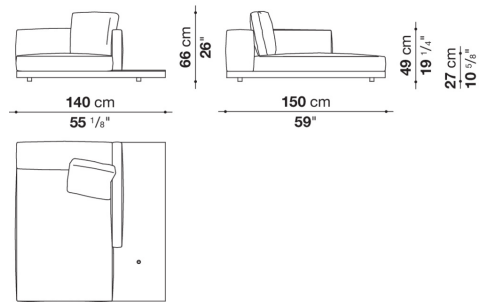

DBL150LS\_2

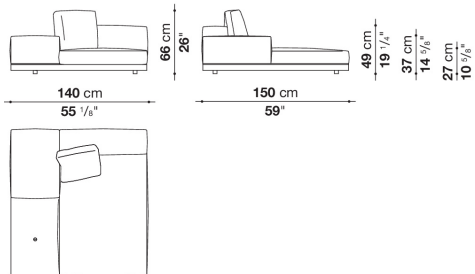

DBL150LD\_2

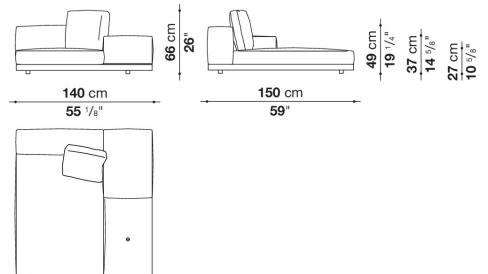

**DBL280P**

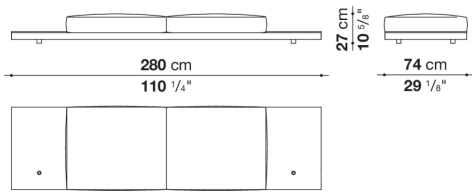

**DBL370P**

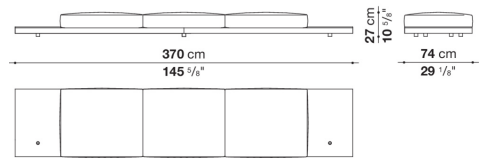

**DBL370PS**

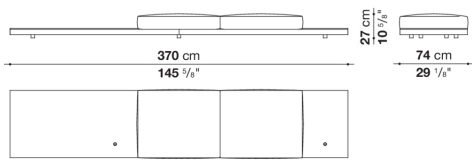

**DBL370PD**

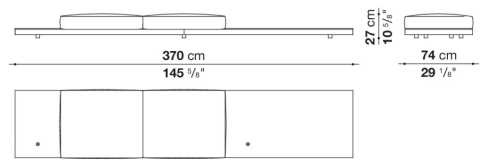

**DBL320PS\_2**

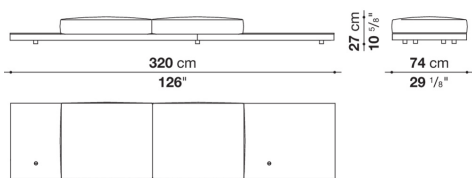

**DBL320PD\_2**

