

Édouard

DIVANI

2016

Antonio Citterio



Descrizione

Édouard è una serie di divani dal forte appeal estetico e funzionale disegnati ottimizzando il comfort grazie all'ampiezza della seduta e allo schienale alto, anche dotabile di poggiatesta, che consente il massimo ed efficiente sostegno ergonomico. Édouard propone divani lineari e componibili con terminali, angolari e chaise longue ed elementi seduta accostabili che permettono di creare aree relax adattabili allo spazio e al gusto personali. Il sistema include una poltrona in due versioni. I rivestimenti sono in tessuto o pelle con eleganti cuciture a rilievo.

Informazioni tecniche

Telaio interno

tubolari e profilati d'acciaio

Imbottitura telaio interno schienale e bracciolo

schiuma di poliuretano flessibile a freddo Bayfit®, fibra di poliestere

Imbottitura cuscino sedile

poliuretano sagomato a densità differenziata

Piedini

alluminio

Puntali

materiale termoplastico

Rivestimento

tessuto o pelle (cuciture a rilievo)

Disegni tecnici

ED183_V

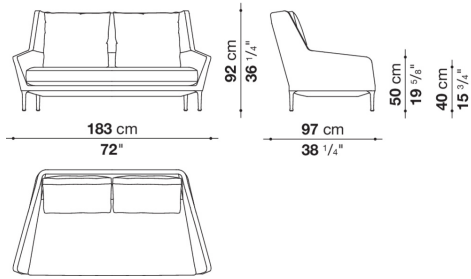

ED225_V

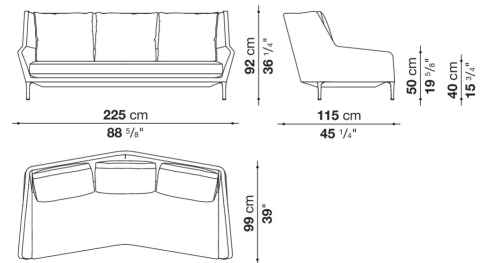

ED255_V

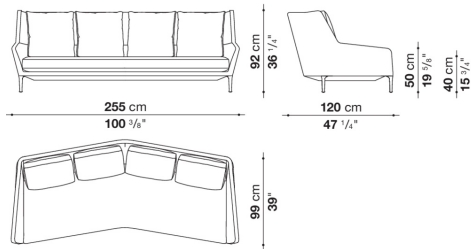

ED176TAS_V

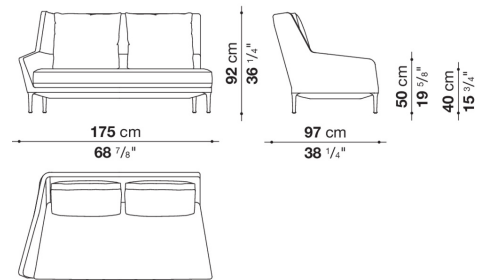

ED176TAD_V

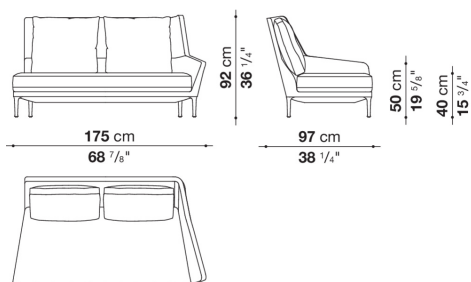

ED183LAS_V

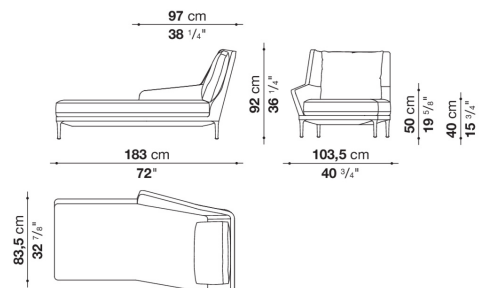

ED183LAD_V

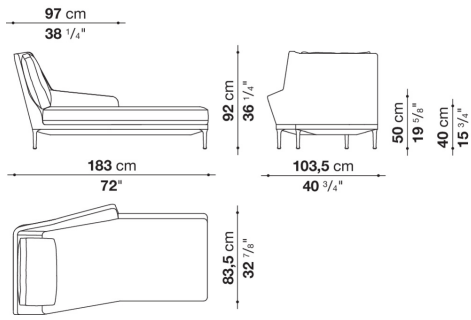

ED176TS_V

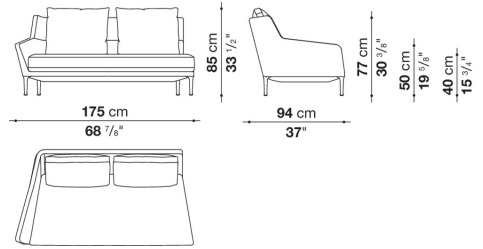

ED176TD_V

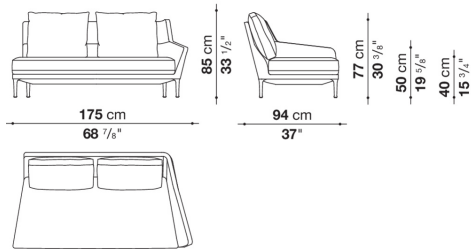

ED221TS_V

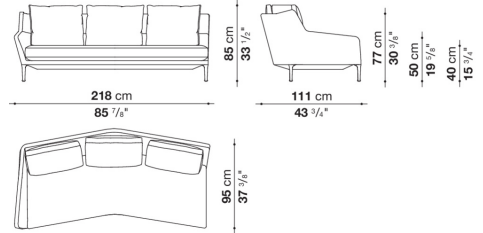

ED221TD_V

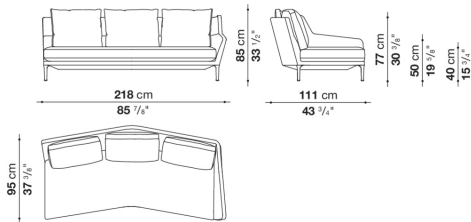

ED230AS_V

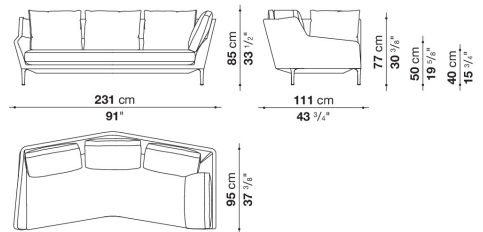

ED230AD_V

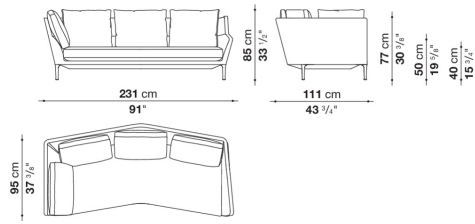

ED180LD_V

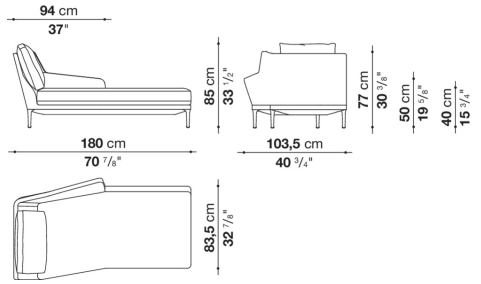

ED180LS_V

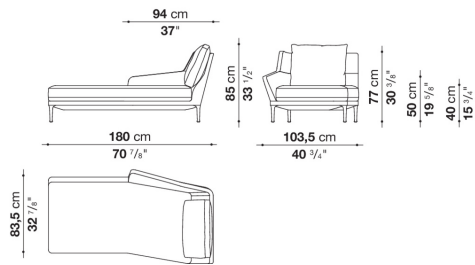

ED222LS_V

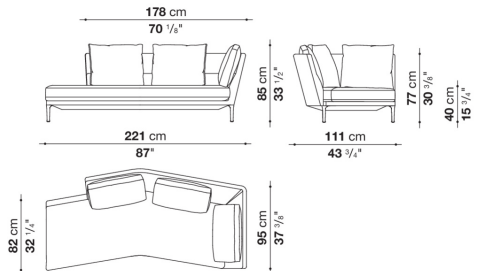

ED222LD_V

